

easy, it's Mocom

CEFLA s.c. reserves the right to modify the products illustrated in the photos without prior notice. 05/2024 MF10GB231501
According to the regulations in force, some products and/or features may have different availability and characteristics in areas outside of the European Union. Please contact your local distributor.

F10

Free to choose. Easy to evolve



BU Medical Equipment
Sede Legale ed Amministrativa
Headquarters
CEFLA s.c.
Via Selice Provinciale, 23/a
40026 Imola (BO) - Italy
Tel. +39 0542 653111
Fax +39 0542 653344

Stabilimento / Plant
Via Bicocca, 14/C
40026 Imola (BO) - Italy
Tel. +39 0542 653441
Fax +39 0542 653601
www.mocom.it
infomocom@mocom.it





Flexibility to support your professional path

The new F10 unit by Mocom, with its stable, floor-fixed unit body and chair, has been designed to implement instant upgrades to support your career development. Whenever you require a new level of performance, your equipment can be fitted with specialist functions and advanced technologies to enable you to reach your next professional objective.

Moreover, the F10 can be equipped with the latest innovations to enhance your skills and facilitate each daily task. These include voice control systems to manage the chair, a selection of ancillary features and even dictate simple observations in the patient records. NFC technology using wearable technologies connect you to your unit and allow for numerous parameter settings for multiple dentists.

F10 can be equipped with an optional interactive application which provides user-friendly info on the status of the various integrated functions via LEDs.

A sensor built into the chair registers the presence of the patient, a feature which is exploited also for statistical data. Lastly, a new brushless micromotor incorporating fluorescent LEDs can be integrated to reveal composite materials and increase your potential for conservative dentistry.





Invest in your future

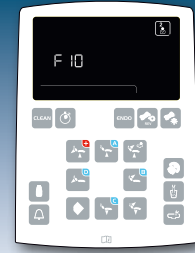

LCD CONTROL PANEL

CONSERVATIVE AND PROSTHETIC DENTISTRY



ENDO MODE

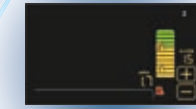

APEX LOCATOR



FULL TOUCH CLINIC CONTROL PANEL

CONSERVATIVE AND PROSTHETIC DENTISTRY



VOICE CONTROL



NFC



ENDO MODE



APEX LOCATOR



IMPLANT MODE



ENDO FILE DATABASE



RECIPROCATING ENDO MODE

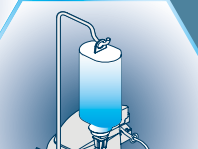

PERISTALTIC PUMP



FULL TOUCH MULTIMEDIA CONTROL PANEL

CONSERVATIVE AND PROSTHETIC DENTISTRY



VOICE CONTROL



NFC



ENDO MODE



APEX LOCATOR



IMPLANT MODE



ENDO FILE DATABASE



RECIPROCATING ENDO MODE



PERISTALTIC PUMP



MULTIMEDIA & VIDEO

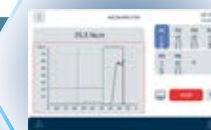

TORQUE CURVES

Superior control

As a standard feature on the new F10 unit the LCD touchscreen panel displays information on the functions used with exceptional clarity. Each instrument and the integrated devices are easily accessed. The perfect choice for conservative dentistry and endodontics, the control unit enables multi-profile settings for up to 4 users. This allows each dentist to customise cuspidor-cup functions, working positions and instrument settings.



Apex Locator

The apex distance is displayed on the LCD display during the instrumentation phase. Nearing of the apex is monitored by the software and the dentist is warned by an audible/visual signal.

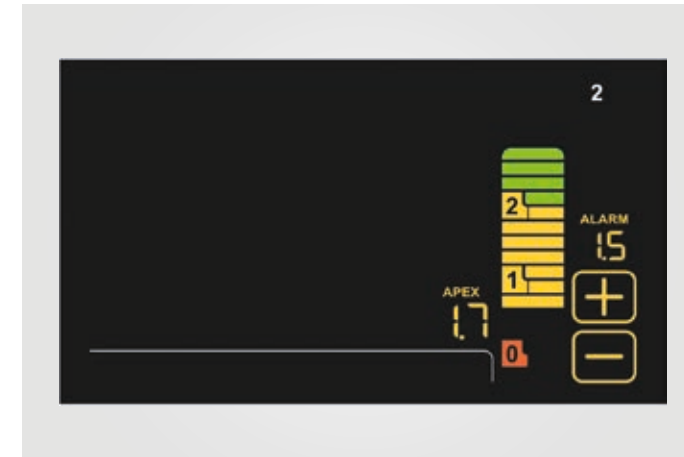

Scaler functions

Dentists use the intuitive control unit to adjust power settings for prophylaxis, but also for endodontic or periodontal treatment.



Timer

Whenever application times need to be monitored, such as during the use of etching gel or compounds, the inbuilt timer keeps everything under control.

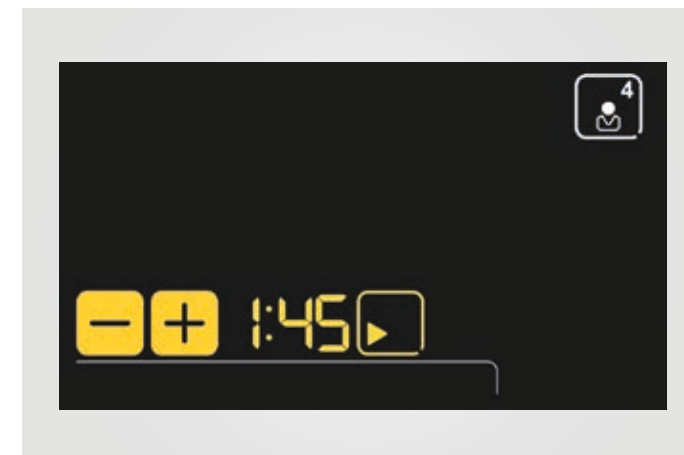

Endodontics

Integrated as an option, together with the i-MMs micromotor, the system for endodontics provides full functionality including Autostop, Autoreverse and Autoforward, as well as an electronic apex locator. During root canal treatment, the colour LCD control unit displays key data to give the dentist full control of the operation.

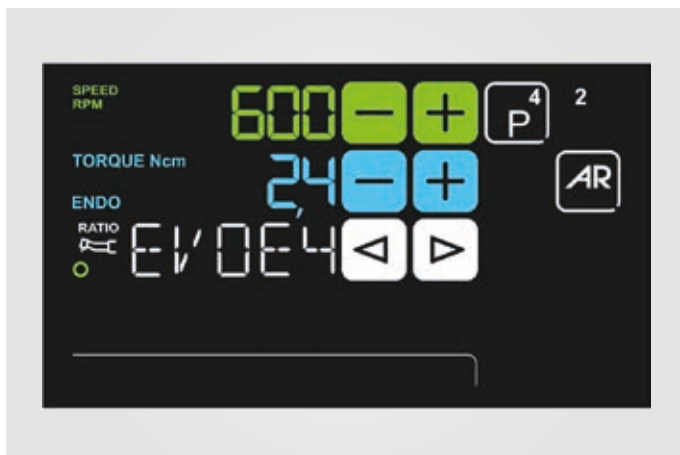

Latest-generation instruments

Excellent workflow and effective treatment are a consequence of fully integrated instruments. The new floor-fixed F10 unit provides dentists with intuitive control over a selection of high-tech micromotors, ultrasound scalers, turbines, contra angles and other handpieces.



Scalers

Compatible with all the best tips on the market, the piezoelectric scalers are available with fibre optics for LED illumination and suitable for prophylaxis, endodontics and periodontal procedures. Fully autoclavable.



Curing light

Featuring an ergonomic swivel joint, the curing light has 6 pre-set programmes and an autoclavable light guide. A high-power LED light source reaches up to 2,200mW/cm² and delivers a 430 to 490nm emission band.



Brushless micromotor

Available with or without LED lighting, i-MMr or i-MMrL are lightweight, silent and vibration-free. Requiring virtually no maintenance, they are ideal for conservative and prosthodontic treatments. Max. speed can be pre-set, torque reaches 3.3 Ncm, speeds range from 100 to 40,000 rpm at a 1:1 ratio. Available as an option, the micromotor can be supplied with fluorescent LED technology that highlights composite materials.



MM with fluorescent LED technology

Using LED-powered fluorescence-aided identification technique, the i-MMs FLUO and iMMrL FLUO brushless micromotors are able to identify the presence of composite materials in teeth. Old composite that needs to be retreated is revealed enabling the dentist to reduce surgery time and operate with greater precision and safety.

Up-to-the-minute technologies

An immediate choice or a subsequent upgrade can be made in the form of the optional Full Touch control unit, which rotates from vertical to landscape layout on the Continental model. This gem of modern technology with a 7" touchscreen display and powerful microprocessor is available in two versions. Clear, intuitive graphics speed up treatment times and facilitate precise settings. As simple to use as a modern smartphone, the control unit offers an up-to-the-minute user experience.

A further optional feature is the voice control system, which minimises physical contact with ancillary systems and facilitates tasks if an assistant is not present.



VOICE CONTROL



Interactive LED Pack

There are several warnings/indicators: their colour provides dentists with a range of useful information, from scaler mode to hygiene cycle progress on the dental unit. During root canal treatment with the apex locator on, the LED ring changes colour, passing from green to yellow to red according to the distance from the apex (this mirrors the on-panel bar colours).

After starting the stopwatch, the LED ring is gradually turned off, flashing briefly when the timer expires.



Clinic

Handles patient chair movements, displays data for conservative work, endodontics and implantology, and manages hygiene devices and other accessory services. Dentists can customise every single setting and storage of multiple profiles is possible up to 4 different operators.

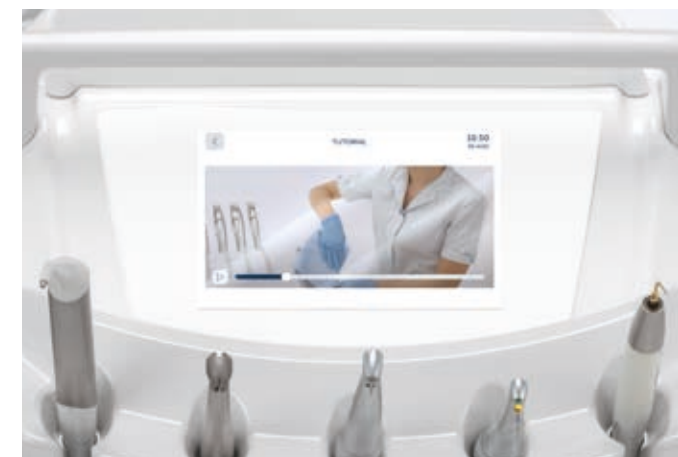

Multimedia

Also features an HD display a USB port and is compatible with multimedia content, which can be stored locally or on a USB stick, also handy for external consultants to save/upload personal settings. The Multimedia version also allows for the management of the operating parameters of any specialist dentistry application.



NFC

Thanks to NFC technology and a smart wristband, dentists can access the F10 to personalise key settings. In proximity of the NFC symbol on the instrument module, the wristband connects and activates the unit's previously stored preferences. 20 slots are available for multiple operators. Settings include patient chair positions, touch display, operating light and cuspidor settings, as well as operating parameters for the integrated instruments.

Features for specialists

Together with the new optional 7" Full Touch control unit, the F10 supports latest-generation technologies and instruments enabling root canal treatments and implantology. Seamless integration between all instruments, applications and comprehensive databases gives rise to an integrated system piloted by the unit's powerful microprocessor. Dentists can switch from conservative mode to ENDO or IMPLANT mode at any time. Full Touch ensures user-friendly controls, personalised settings and displays key treatment-specific data. Both the Clinic and Multimedia versions adopt a dedicated interface for the specialist treatment in progress.

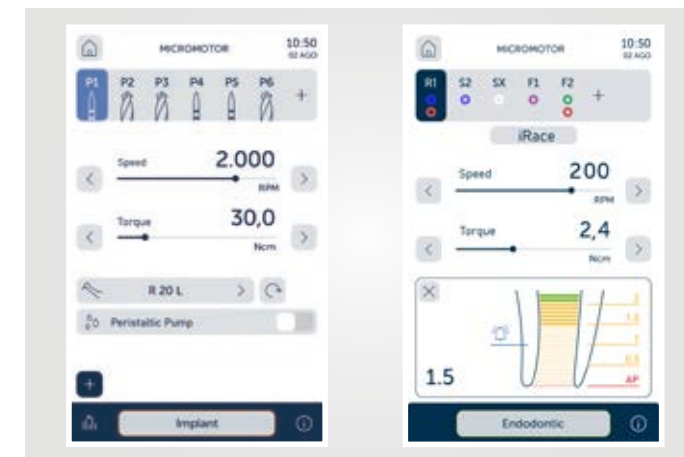

The endodontic file identification trademarks are not owned by Cefla or any of its associated companies.

Implantology

An integrated set of systems for implantologists avoids the need for space-consuming stand-alone devices. Managed via the control unit, dentists can set and save clinical parameters for each treatment stage, from site preparation to implant placement.

Endodontics

Giving access to a pre-loaded library, the Full Touch control unit manages treatment with rotary instruments and with reciprocating instruments, in the optional mode. With the dedicated contra angle, the apex locator displays distance to the apex on the display. A buzzer warns of apex approach and micromotor rotation is automatically disabled when the apex is reached.



Peristaltic pump

The peristaltic pump is managed via the Full Touch control unit and does away with the need for additional modules or carts around the patient chair.

Torque curves

Dentists can record the torque curves during treatment. Data is produced in an exportable format to keep a record of delivered torque and implant tightening torque values.



EVO E4 contra angle

Conceived for endodontics, the EVO E4 contra angle with a 4:1 ratio features a miniaturised head for easy access to all treatment areas. Recommended for endodontic treatment in reciprocating mode and using the integrated apex locator, it can be autoclaved and heat-disinfected.



i-MMs micromotor

Easily autoclaved, i-MMs (optional) suitable for endodontics and for implant surgery. Torque control up to 70 Ncm when combined with the appropriate 20:1 ratio contra angle, and speeds ranging from 100 to 40,000 rpm make it the perfect answer when ultimate performance and control are required.

Versatile ergonomics

Ergonomically versatile, the Continental version of the F10 unit with over-the-patient delivery is also highly compact with its floor-fixed unit body and chair. The instrument module is lightweight and incorporates an optional handle-mounted sensor for easy, precise vertical positioning. Excellent mobility of the arm system facilitates workflow and improves operating comfort for the dental surgeon.



SideFlex

Special optional SideFlex joints that allow instrument levers to move laterally without causing wrist fatigue optimise mobility. Levers are removable for cleaning purposes.



Compact tray

The tray holder housed under the module is made of stainless steel. Simple to reposition, it is easily rotated and accessed by both dentist and assistant.



Instrument excursion

Ample instrument tubing excursion makes it easy and effortless to reach all operating positions around the patient. Instruments are self-balancing for additional comfort.

Functional design

Designed functionally to facilitate the movements made by each dentist as they accomplish daily tasks, the International version of the F10 unit with hanging tubes boasts an arm system capable of reaching all working positions around the operating area. The module is compact and easy to manoeuvre, and the instruments are simple to extract thanks to the module's ergonomic design and the different inclination of each handpiece.



Ceramic cuspidor unit

Equipped with an optical sensor for cup-filling, the cuspidor bowl rotates conveniently for smoother workflow and additional patient comfort.



Assistant's module

The module is available with 4 or 5 housings. In addition to syringe and suction cannulae, a camera and a curing light or a dynamic instrument can be installed. An optional adjustable tray holder is available.



Adjustable height

The assistant's module is fitted to an articulated arm, allowing for convenient height adjustment.

Attractive combinations

Making a patient feel good before treatment even starts can be done in a number of ways. To start with, the studio can be made attractive with the right colours and the chair can be fitted with Memory Foam padding. The F10 offers unit body and patient chair combinations based on a wide selection of colours for upholstery and 3 choices for the unit body colouring. The optional Memory Foam padding is also available in the full colour range.



Standard

- 102 Atlantic blue
- 106 Mediterranean blue
- 113 Pacific blue
- 136 Indian blue
- 132 Blueberry violet
- 134 Japanese wisteria
- 135 Venetian red
- 115 Scottish salmon
- 103 Nevada yellow
- 123 Polynesian green

- 101 Caribbean green
- 137 Bright silver
- 121 Anthracite grey
- 130 Graphite black
- 142 Anatolian Hazelnut
- 141 Papyrus Beige
- 143 Arabian Gold
- 140 Brazilian Brown
- 144 Ruby Red

Memory Foam

- 198 Atlantic blue
- 196 Mediterranean blue
- 183 Pacific blue
- 186 Indian blue
- 192 Blueberry violet
- 184 Japanese wisteria
- 194 Venetian red
- 195 Scottish salmon
- 182 Nevada yellow
- 193 Polynesian green

- 197 Caribbean green
- 187 Bright silver
- 199 Anthracite grey
- 180 Graphite black
- 172 Anatolian Hazelnut
- 171 Papyrus Beige
- 173 Arabian Gold
- 170 Brazilian Brown
- 174 Ruby Redo

Unit body design

Compact and cleanly designed, the unit body can be supplied in white, blue or silver grey optional colours to add a personal touch of design to the operatory. Seamless upholstery available in 14 different colours is available with standard or special Memory Foam padding.

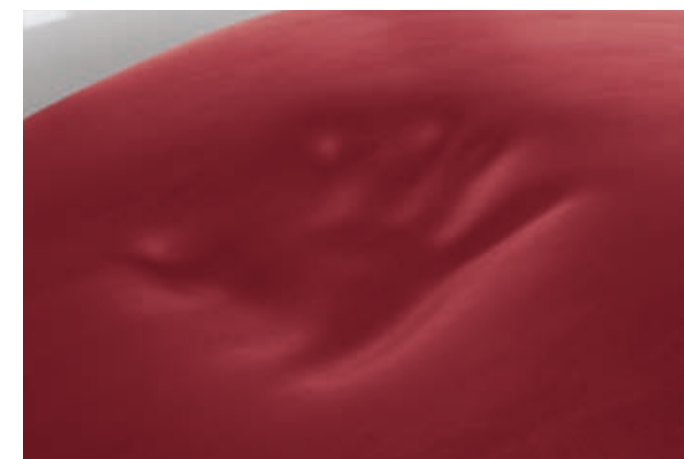

Memory Foam

Optional padding ensuring correct anatomic support is suitable for patients of all builds, an aspect that gains in importance during longer treatment sessions when comfort is crucial.

Comfort is a priority

The question of wellbeing is key to every treatment session and every patient, but also concerns the staff operating around the patient chair. And the central point is the patient chair and how it is designed. The F10 makes comfort a priority. Designed to allow easy access to the operating area, the patient chair features an ergonomic joint synchronising the movement between backrest and seat to avoid lumbar compression and the need to repeatedly realign the patient.



Lift capacity

The patient chair is certified to lift patients weighing up to 190 kg and has an extensive range of vertical excursion, from 37 to 80 cm.



Foot controls

Three different ergonomic designs are available, both in wired and wireless versions. These allow activation of Chip Air/Water, patient chair movement and recall of saved positions. In surgical mode, all the pedals can activate the peristaltic pump, turn on/off the lamp and change the programme. Power Pedal manages an extra two saved positions.



Headrest

In addition to an adjustable 2-axis version with a mechanical lock, the optional model features a pneumatic lock system and 3-axis movement for free, precise positioning. Simple to activate by pressing a small button, the dentist can adjust the headrest with no effort at all.

A choice of operating lights

Dentists can choose between LED and halogen lamps. The as-standard light on the unit is the halogen Venus Plus, while the two optional lights belong to the LED generation, completing the broad selection of operating lamps available. The highly versatile concept of the MCT version allows the dentist to select the correct colour temperature according to each clinical situation. With the introduction of the optional voice control system on the F10 unit, staff can interact with the Venus MCT light in a practical, modern and aseptic way.



Venus Plus

Ergonomic operating light with 3-axis rotation, protective front screen and removable handles for easy disinfection. Perfect in all clinical situations, the lamp features a soft-start function and has a colour temperature of 4900K. Light intensity ranges from 8,000 to 35,000 Lux and is adjusted via a potentiometer.



Venus Plus-L LED

LED operating lamp with hermetically sealed front screen. Potentiometer-adjustable light intensity, from 3,000 to 50,000 Lux. Colour temperature 5000K. On-off control also via infrared sensor.



Venus LED MCT (Multi Colour Temperature)

Latest-generation operating lamp with 3 different colour temperatures: 4300K (warm light) for surgical treatment, 5000K (neutral light) for conservative dentistry and 5500K (cool light) for realistic colour capture. Composite Mode function adapts light wavelength to prevent pre-polymerisation, while ensuring optimal lighting.

Certified systems

All controlled directly by the microprocessor inside the control unit, the active hygiene devices address all major issues concerning contamination within the operatory. Parameters can be personalised and dentists can choose to activate systems manually or use pre-set times and settings. Certified systems are the best way of demonstrating one's commitment to the health of a patient and protect staff operating all day long.



W.H.E.

Certified DVGW continuous disinfection system prevents backflow contamination of the unit's water supply acting against all water-borne contaminants, including Legionella. Use of Peroxy Ag+ recommended. Used on a daily basis in conjunction with one intensive BIOSTER disinfection cycle, bacterial loads are kept at zero.



BIOSTER

Automatic system that disinfects internal instrument spray circuits with an antiseptic liquid (Peroxy Ag+). Certified by the Sapienza University of Rome, this device eradicates microbes and is recommended for end-of-day disinfection. Instruments can be placed conveniently in the integrated housings and a large tank for disinfectant minimises re-filling frequency.



Flushing

This system, also included in the BIOSTER system, gives the spray ducts a fast rinse to eliminate any stagnant liquid from tubing. Ideal at the start of each day and after each patient.



A.C.V.S.

Automatic system for the flushing and cleansing of the suction system. Allows sanitisation to be performed between one patient and the next.



S.H.S.

Device that feeds water to the sprays as an independent alternative to mains water. Works by way of a tank filled with distilled water: this prevents limescale build-up. Extremely useful where mains water is hard or potentially unsafe.



O.D.R.

As-standard mechanism that automatically emits an air jet to clean any residual liquids or solids from the handpiece after use.



Constant protection

Reducing the risk of cross-contamination has guided the concept behind the F10 unit. Protection has to be constant, so all exposed areas and removable components were considered in the conceptual design phase. Based on this in-depth research, precautions have been taken to provide a unit with design elements conceived to protect patients and medical staff, thereby ensuring a safe and risk-free working environment.



Cuspidor bowl unit

Fully removable for fast, effective sanitisation, the cuspidor bowl unit consists of parts that are easy to clean and disinfect (ceramic as standard or, as an optional, glass).



Removable instrument levers

Instrument levers featuring the optional SideFlex joint can be removed for better cleaning.



Cannulae guides

Easy-to-remove elements ensure perfect cleanliness in what is a potentially critical area.



Quick couplings

Release system for cleaning and/or replacement.



Double filters

These easily removable filters make emptying and cleaning tasks simple.



Handle

The Continental module handle can be removed for disinfection purposes.



Operating light

Handles are removable and autoclavable.

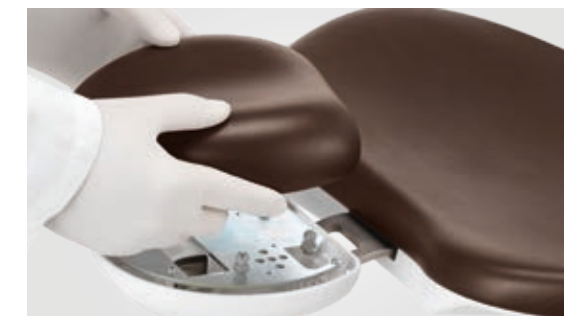

Upholstery

Easy-to-sanitise, durable seamless padding.

Communication and consent

The F10 unit can be equipped with an integrated chairside communication system to share information with the patient, gain consent for treatment and illustrate the results. Dentists will also enjoy the ability to shorten the initial diagnostic steps, getting visual data in high resolution. An integrated system with an HD camera, LED monitor, plus the opportunity of viewing data directly on the optional Full Touch control unit display is highly efficient.



Images and video

When installed, the Multimedia version of the Full Touch control unit enables viewing of video footage and camera images, as well as short video sequences regarding the use and maintenance of the dental unit. This high-tech feature speeds up several tasks and increases productivity through improved workflow.



C-U2 camera

The integrated HD camera with an optical system comprising 7 glass lenses features a streamlined design and a 16:9 format HD sensor providing high-resolution images on the 16:9 LED monitor or, when present, the 7" Full Touch display. Manual focusing is not required thanks to the 5 – 70 mm depth of field. The 90° viewing angle is partially retroflexed and freeze-frames can be obtained via the foot control or the touch-sensitive key on the handpiece.



22" LED monitor

The 16:9 monitor is a certified medical device and provides a wide viewing angle thanks to the special IPS panel. The monitor can be fitted to the F10 either with a single arm or a double-jointed arm for a more comfortable use.



Chairside diagnosis

Thanks to its solid, stable concept which benefits from a unit body firmly anchored to the floor, the F10 is ideal when it comes to integrating a wireless-controlled high-frequency X-ray unit. Further high-tech devices including a built-in X-ray sensor. Integration reduces the time required to obtain diagnostic images and accelerates workflow, also thanks to the handheld wireless control device, which sets exposure parameters automatically.



RXDC with eXTend technology

Thanks to an extensive internal collimation and an extremely small focal spot, the X-ray unit provides high-quality images combined with a minimal radiation dose delivered to the patient to quickly make a correct, accurate and safe diagnosis.



Zen-X

The integrated X-ray sensor, available in two sizes, is fitted directly onto the dentist's module. In a matter of seconds, the reprocessed image is displayed on the 22" LED monitor if present. Captured X-rays can also be viewed on a connected PC or on the optional Full Touch display (Multimedia version).



Multimedia display

X-rays acquired via the integrated system can be displayed in HD on the optional 7" Full Touch display.

Virtual assistance

The F10 will connect via internet to provide dental surgeries with remote assistance and key technology updates. Without the need to download software, the dentist has online access to the user manual and a selection of video tutorials to make the most of their equipment.



The cloud-based platform can be used to record performed disinfection cycles. Via a simple dashboard, Di.V.A. also helps dentists monitor unit usage, instrument usage and analyse surgery efficiency. In larger facilities, Di.V.A. manages staff workloads and plans equipment maintenance. Useful information is also provided by the sensor integrated into the patient chair. All data are conserved online and fully protected according to "Data Protection Certified" standards.

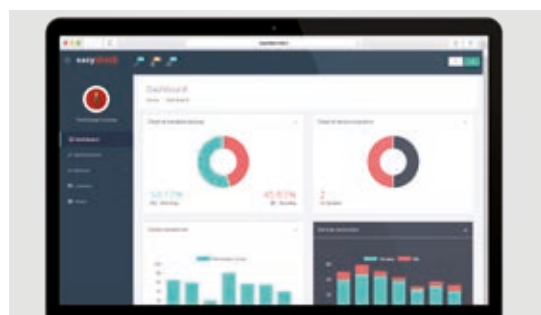

easycheck

With the aim of improving the effectiveness of the clinic, each F10 unit connected via Easy Check benefits from a real-time diagnostic service and remote technical support.

Multi-Junction system

There are no longer any obstacles or expense involved in connecting the dental unit to the floor. With the multi-junction system, replacing the previous dental unit with the new F10 is simple and straightforward, as the appropriate installation kit can be selected according to the existing floor connections.

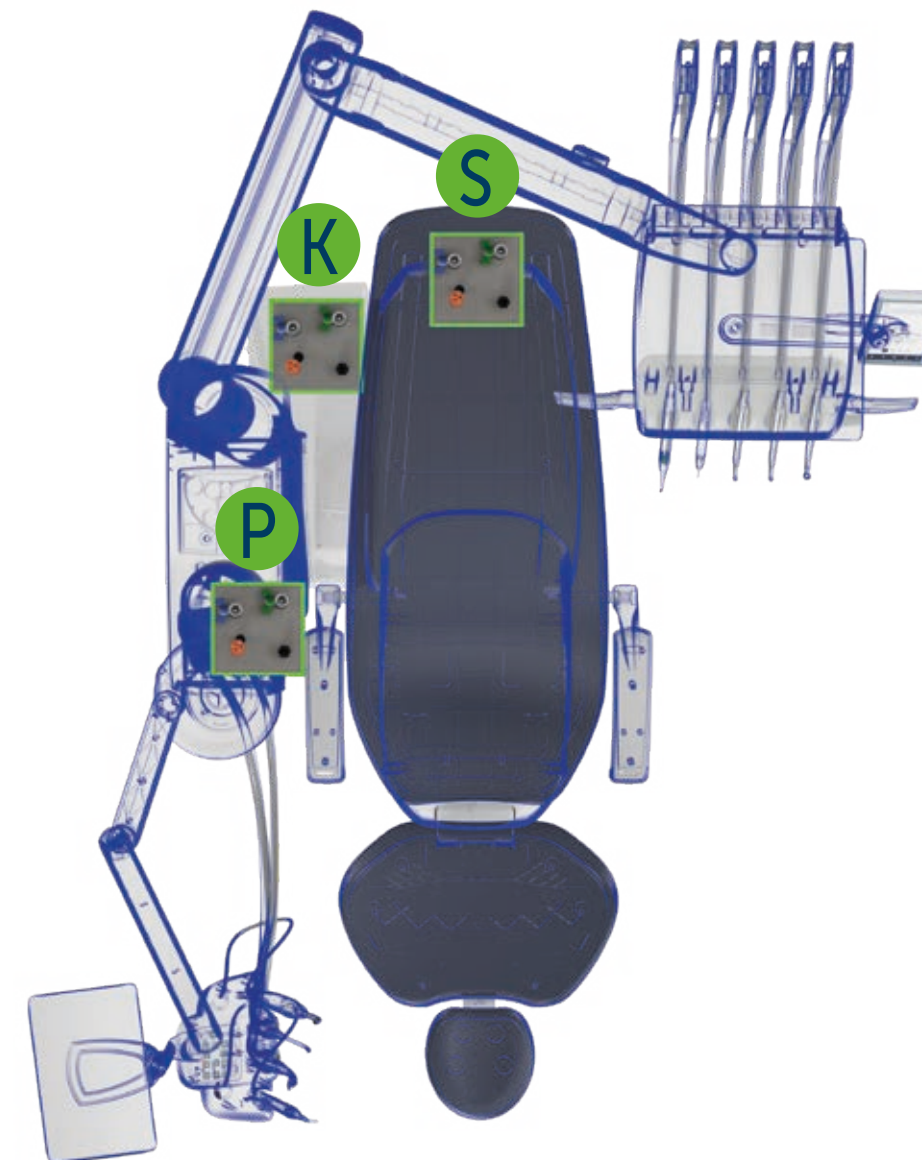

Wide choice of installation

Standard (S and K included) - enables connection to existing points, either beneath the leg rest or beneath the front of the unit body.

Optional kit P - connections are located beneath the rear of the unit body.

Technical specifications

F10	CONTINENTAL	INTERNATIONAL
PATIENT CHAIR		
Left armrest	●	●
Right armrest	○	○
Double-jointed headrest with 2-axis movement	●	●
Pneumatic headrest with 3-axis movement	○	○
Multifunction foot control	●	●
Pressure-operated foot control	○	○
Power pedal foot control	○	○
Wireless Multifunction foot control	○	○
Wireless Pressure-operated foot control	○	○
Wireless Power pedal foot control	○	○
DENTIST'S MODULE		
LCD Touch display control unit	●	●
Full Touch CLINIC 7" control unit	○	○
Full Touch MULTIMEDIA 7" control unit	○	○
LEFT SIDE PACK		
Pneumatic brake	○	○
Instrument SideFlex kit	○	-
Warm water spray	○	○
3-way Syringe	●	●
6-way Syringe	○	○
Midwest module with f.o.	●	●
Scaler (with and without f.o.)	○	○
Micromotor i-MMr (100-40000 rpm/3.3 Ncm)	●	●
Micromotor i-MMs f.o. (100-40000 rpm/5.3 Ncm) ENDO & IMPLANT function*)	○	○
Micromotor i-MMrL FLUO with FIT technology	○	○
Micromotor i-MMs FLUO with FIT technology	○	○
Reciprocating Mode module	○	○
Electronic Apex Locator module	○	○
Peristaltic Pump module	○	○
Sixth Instrument kit (curing light or camera)	○	○
Zen-X sensor application	○	○
ASSISTANT'S MODULE		
Assistant's Module with 4 housings	●	●
Assistant's Module with 5 housings	○	○
Assistant's Module tray holder	○	○
UNIT BODY		
Ceramic bowl manual movement	●	●
Glass bowl manual movement	○	○
Bowl with electro-mechanical movement	○	○
Cup-fill sensor	○	○
Cup-fill warm water	○	○
Interactive LED Pack	○	○
HYGIENE SYSTEMS		
S.H.S. independent water supply	●	●
Flushing	●	●
Bioster	○	○
W.H.E.	○	○
Cannulae Flush	○	○

OPERATING LIGHT		
Venus Plus	●	●
Venus Plus L-LED	○	○
Venus LED MCT	○	○
PATIENT COMMUNICATION		
Monitor support arm	○	○
Medical monitor	○	○
C-U2 HD camera	○	○

* IMPLANT function only with Full Touch CLINIC/MULTIMEDIA 7" control unit and peristaltic pump module

● as standard ○ optional - unavailable

CONTINENTAL

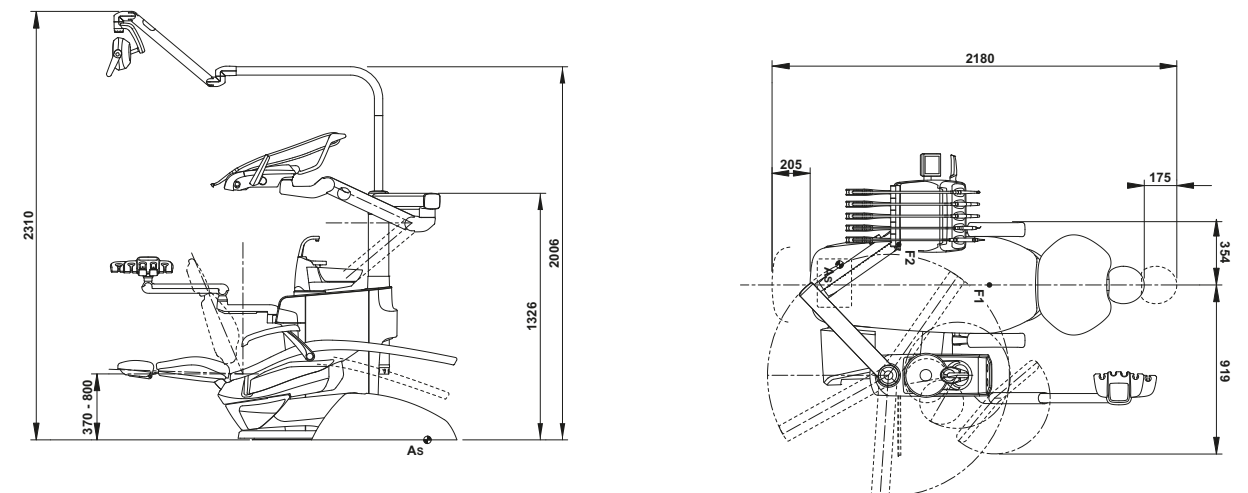

INTERNATIONAL

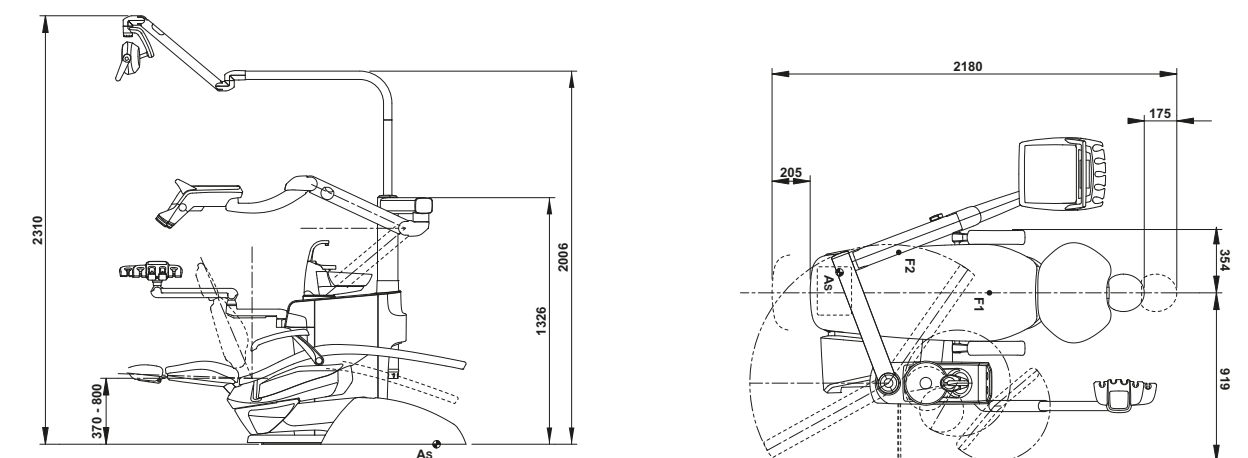

The measurements shown in the drawings are in mm.